



STADE VÉLODROME OLYMPIQUE DE MARSEILLE

LIMITED EDITION



STADE VÉLODROME OLYMPIQUE DE MARSEILLE

Stade Vélodrome, the iconic home stadium of Olympique de Marseille, is an important symbol in French football and sports culture. This detailed miniature stadium captures the unique architecture of the stadium, including the sculptural undulating roof and distinctive lighting. A must-have for every OM fan!

Stade Vélodrome was originally designed in the 1930s by French architect Henri Ploquin. In its early years, it served as a multi-purpose sports venue, combining a stadium, athletics track, and velodrome. In the 1970s, the cycling and athletics tracks were removed, and the stadium underwent several renovations. However, the name Stade Vélodrome was always retained. The most recent renovation took place in 2014, just before the UEFA Euro 2016, during which the stadium was fitted with its iconic sculptural roof. This distinctive undulating roof follows the contours of the old open terraces from 1998, giving the stadium a modern appearance.

The striking new roof was specially redesigned by Stadiums For Ants using advanced 3D software and printed with the latest techniques. The result is a miniature with stunning details, where the undulating roof shapes come to life. Additionally, the model is equipped with subtle blue ambient lighting on both the interior and exterior, capturing the stadium's atmosphere perfectly. Stade Vélodrome is not only the home of Olympique de Marseille but has also been the site of significant moments in French football history. In the old stadium, the French national team reached the final of the 1984 European Championship, led by captain Michel Platini, after a legendary victory over Portugal. The stadium was also the scene of Dennis Bergkamp's famous goal in the 1998 World Cup quarterfinal against Argentina, one of the most beautiful goals in World Cup history.

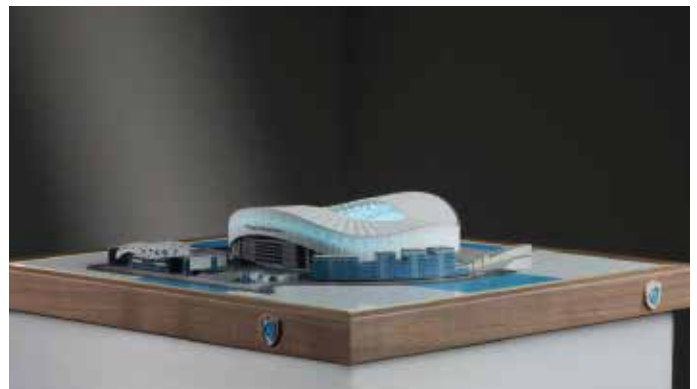
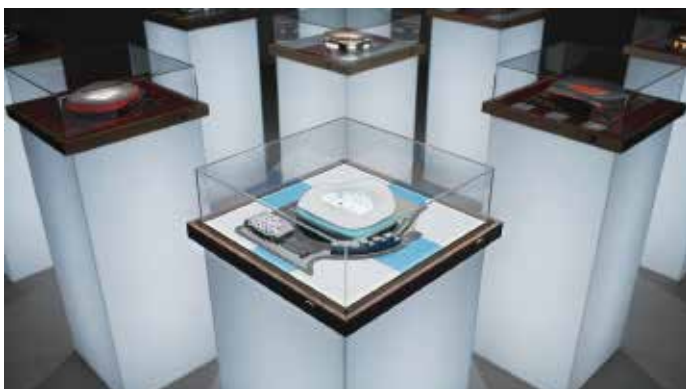

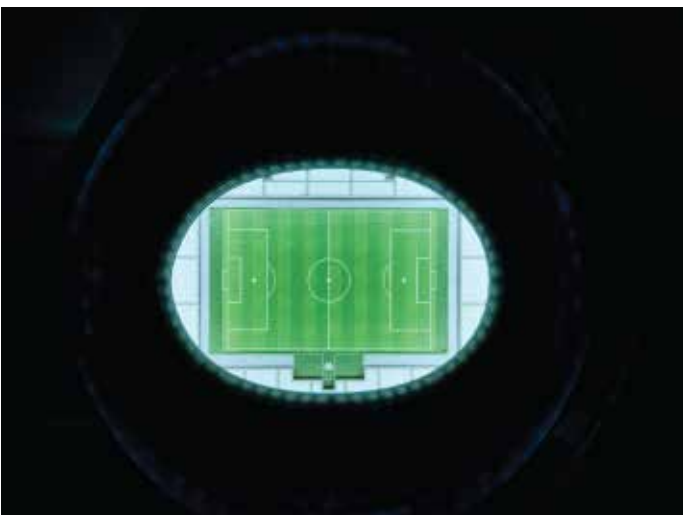
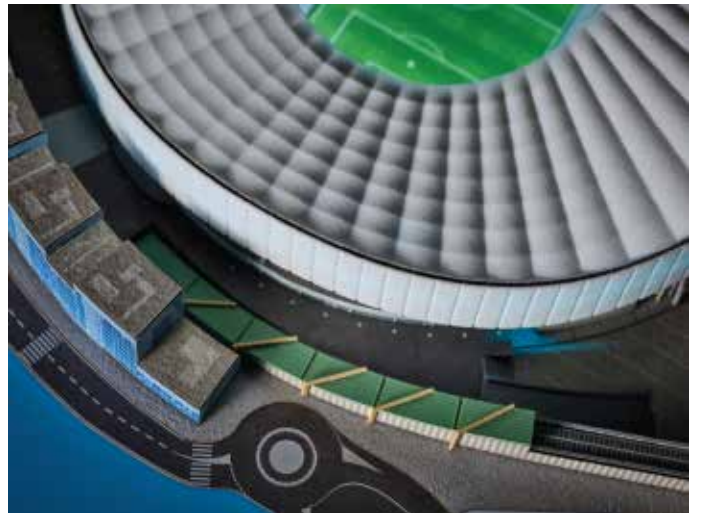
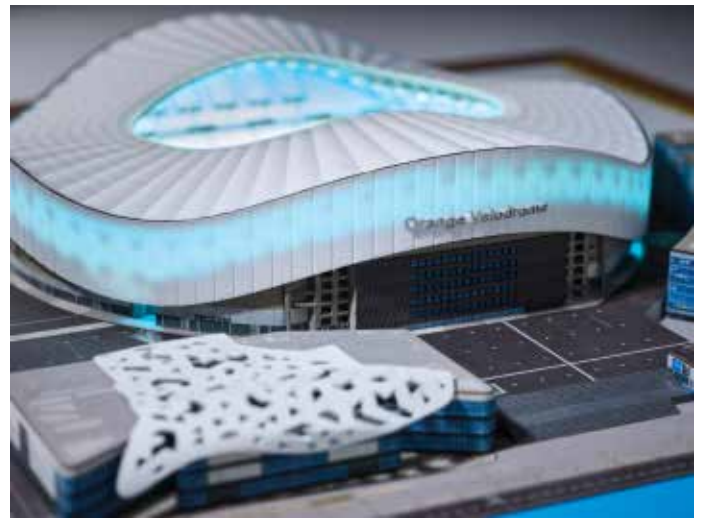
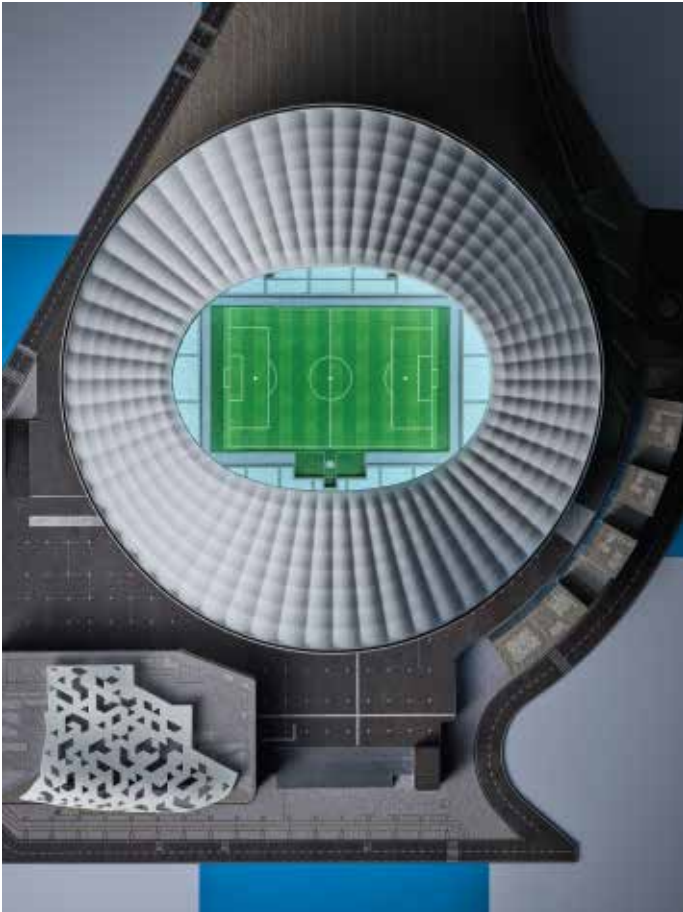

SIZING

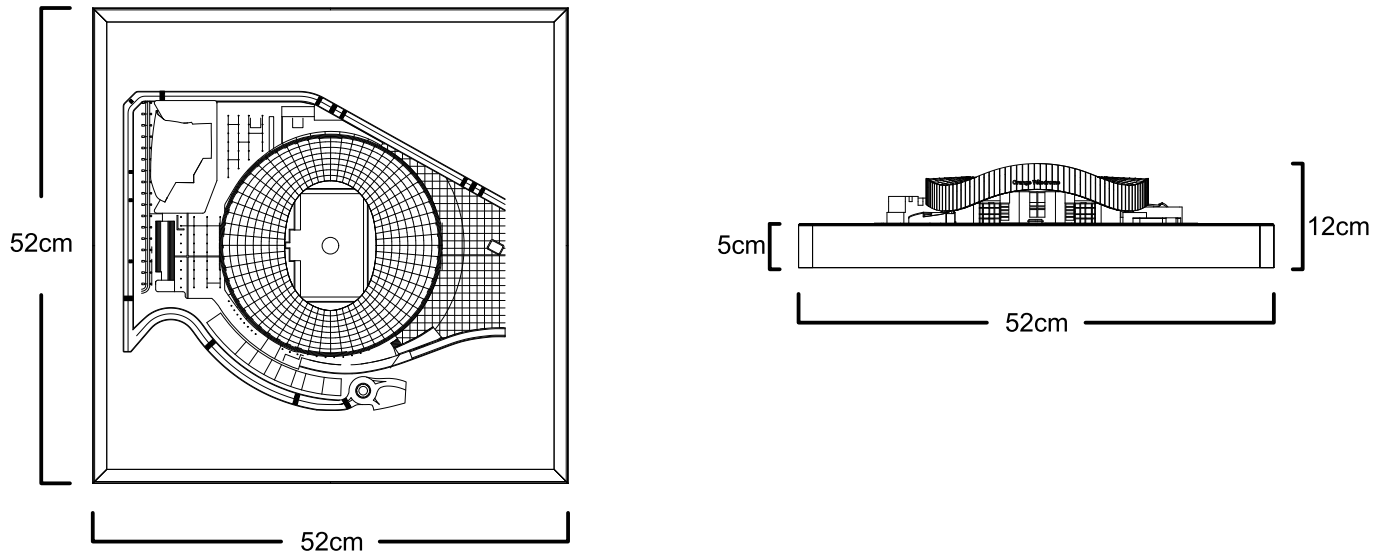

Dimensions: 55 cm x 55 cm x 12 cm
 Weight Premium Edition: Approx. 8 kg

Material:

- Base Plate – Acrylic
- Frame – Solid Wood
- Stadium – 3D printed parts, created with various technologies
- Decals – PVC-free stickers
- Lighting – LED strips
- Power Supply – USB cable, wall adapter not included

Stadiums For Ants uses advanced LED techniques to realistically light their miniature stadiums. The field lighting is provided by precise (white) LED spotlights, creating a lifelike appearance on the field. Around the stadium, diffused ambient lighting creates a natural, atmospheric glow. The entire setup runs efficiently on 5 volts and is powered directly via a wall adapter, ensuring stable and safe energy supply.

Maintenance:

Frame/Plate – Clean with a dry cloth, no cleaning products

Stadium – Do not clean the stadium itself. Only use compressed air to remove dust



STADIUMS FOR ANTS

To learn more about the project and stay updated
with new models, visit our official website:

www.stadiumsforants.com

Lijnbaansgracht 56a
1015GS Amsterdam
Mail: info@stadiumsforants.com